



**JoistPro 150XP**  
**JoistPro 250XP**

# Metal Connectors

Operating Instructions

Instrucciones de Operacion

Mode d'Emploi

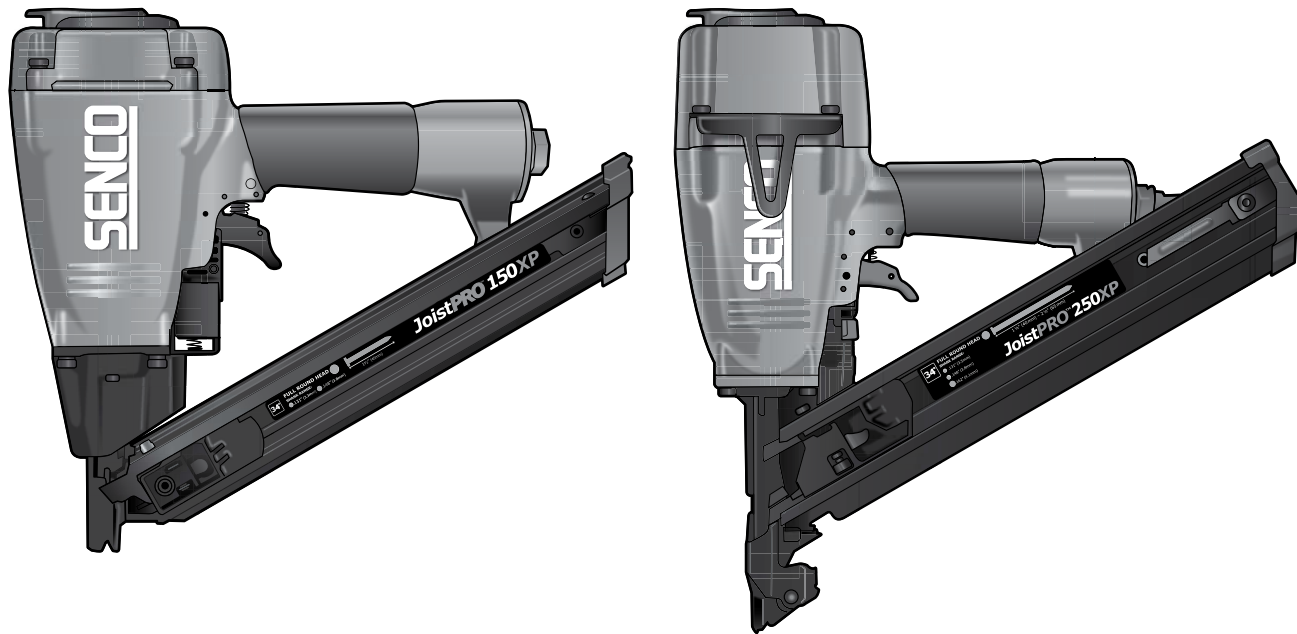

# SENCO®

**Senco Brands, Inc.**  
4270 Ivy Pointe Blvd.  
Cincinnati, OH 45245  
1-800-543-4596  
[www.senco.com](http://www.senco.com)



Warnings for the safe use of this tool are included in this manual.  
Los avisos para el uso seguro de esta herramienta están incluidos en este manual.  
Les consignes pour l'utilisation en toute sécurité de cet outil se trouvent dans ce manuel.

**NFD86K7L • September 3, 2014 (Replaces 11/6/2013)**



ENGLISH	ESPAÑOL	FRANÇAIS
---------	---------	----------

TABLE OF CONTENTS		TABLA DE MATERIAS		TABLE DES MATIÈRES	
TOOL USE	2	USO DE LA		UTILISATION DE L'OUTIL	2
MAINTENANCE	6	HERRAMIENTA	2	ENTRETIEN	6
TROUBLESHOOTING	7	MANTENIMIENTO	6	DÉPANNAGE	7
SPECIFICATIONS	8	IDENTIFICACIÓN		SPÉCIFICATIONS	8
ACCESSORIES	8	DE FALLAS	7	ACCESSOIRES	8
		ESPECIFICACIONES	8		
		ACCESORIOS	8		

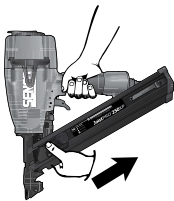
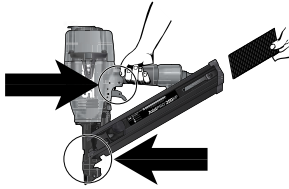
EMPLOYER'S RESPONSIBILITIES	RESPONSABILIDADES DEL EMPLEADOR	RESPONSABILITÉS DE L'EMPLOYEUR
Employer must enforce compliance with the safety warnings and all other instructions which accompany this tool as shipped from the manufacturer.	El empleador debe hacer cumplir las advertencias de seguridad y todas las otras instrucciones que acompañan a esta herramienta como se la despacha desde el fabricante.	L'employeur doit faire appliquer les consignes de sécurité et toutes les autres instructions qui accompagnent cet outil tel qu'il est livré par son constructeur.
Keep this manual available for use by all people assigned to the use of this tool.	Mantenga este manual disponible para que lo usen todas las personas destinadas a hacer uso de esta herramienta.	Ayez ce manuel à la disposition de toutes les personnes chargées d'utiliser cet outil.
For personal safety and proper operation of this tool, read and understand all of these instructions carefully.	Por razones de seguridad personal y la adecuada operación de esta herramienta, lea y comprenda todas estas instrucciones cuidadosamente.	Pour assurer la sécurité personnelle et le bon emploi de cet outil, lisez et assimilez soigneusement toutes ces instructions.



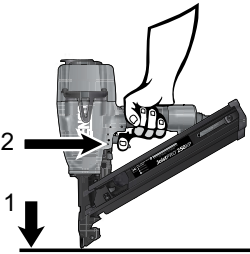
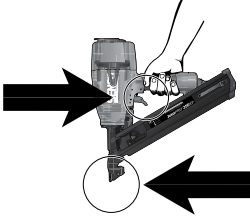

TOOL USE		USO DE LA HERRAMIENTA	UTILISATION DE L'OUTIL
ENGLISH	ESPAÑOL	FRANÇAIS	
<ul style="list-style-type: none"> <li>● Read and understand "SAFETY INSTRUCTIONS" manual shipped with this tool before using tool.</li> </ul>	<ul style="list-style-type: none"> <li>● Antes de usar la herramienta lea y comprenda el manual "INSTRUCCIONES DE SEGURIDAD" despachado con ella.</li> </ul>	<ul style="list-style-type: none"> <li>● Lisez et assimilez le manuel "Instructions de sécurité" livré avec cet outil avant de l'utiliser.</li> </ul>	
<ul style="list-style-type: none"> <li>● Keep tool pointed away from yourself and others, and connect air to tool. Tools shall be operated at the lowest pressure needed for application. This will reduce noise levels, part wear, and energy use.</li> </ul>	<ul style="list-style-type: none"> <li>● Mantenga la herramienta apuntando en dirección opuesta de usted y de otros y conecte el aire a la manguera.</li> </ul>	<ul style="list-style-type: none"> <li>● Maintenez l'outil pointé à l'écart de vous-même et des autres personnes et raccordez l'outil à l'air comprimé. Les outils doivent être utilisés à la pression la plus faible requise pour le travail à faire. Cela réduira le niveau de bruit, l'usure de l'outil et la demande en énergie.</li> </ul>	
<ul style="list-style-type: none"> <li>● Never use a tool that leaks air or needs repair.</li> </ul>	<ul style="list-style-type: none"> <li>● Nunca use una herramienta que tenga escapes de aire o que necesite ser reparada.</li> </ul>	<ul style="list-style-type: none"> <li>● N'utilisez jamais un outil qui a des fuites d'air ou qui a besoin d'être réparé.</li> </ul>	
<ul style="list-style-type: none"> <li>● To Load: Insert strip of nails into rear of magazine. For optimum performance use SENCO fasteners. Do not load with workpiece contact (safety element) or trigger depressed.</li> </ul>	<ul style="list-style-type: none"> <li>● Para cargar: Inserte la tira de clavos en la parte de atrás del área de almacenamiento. Use solamente sujetadores SENCO auténticos. No cargue con el disparo o la seguridad oprimidos.</li> </ul>	<ul style="list-style-type: none"> <li>● Pour charger : Introduisez une bande de clous dans la partie arrière du magasin. Utilisez uniquement les véritables clous SENCO. Veillez à ne pas appuyer sur le palpeur de sécurité ou sur la détente quand vous chargez.</li> </ul>	
<ul style="list-style-type: none"> <li>● Pull feeder shoe back.</li> </ul>	<ul style="list-style-type: none"> <li>● Tire la zapata del alimentador.</li> </ul>	<ul style="list-style-type: none"> <li>● Tirez le poussoir en arrière.</li> </ul>	

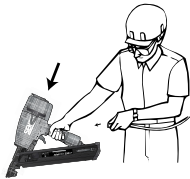
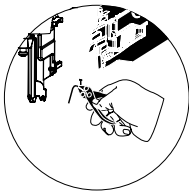
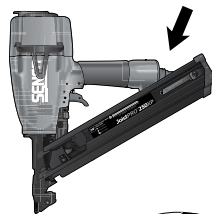
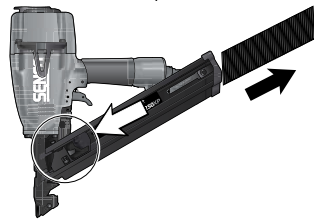
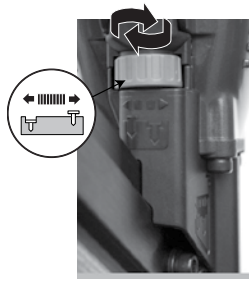
TOOL USE	USO DE LA HERRAMIENTA	UTILISATION DE L'OUTIL
ENGLISH	ESPAÑOL	FRANÇAIS
 <ul style="list-style-type: none"> <li>● With a Single Sequential (Restrictive) trigger mode, nails can only be driven one way. First depress workpiece contact (safety element) against work surface then pull trigger. This feature is helpful when precise fastener placement is required.</li> <li>● Read the “Customer Satisfaction and Safety Reminder” (CSSR) in the tool and fastener boxes for safety information regarding the Contact-Actuation and Sequential trigger modes. Under certain conditions, the Sequential trigger mode may reduce the possibility of injury to you or to others working with you.</li> </ul>	<ul style="list-style-type: none"> <li>● Con el modo único de activación Secuencial (Restrictivo), los clavos pueden insertarse de una sola manera. Primero oprima el contacto con la pieza de trabajo (elemento de seguridad) contra la superficie de trabajo, y luego tire del gatillo. Esta característica es útil cuando se necesita una colocación precisa del sujetador.</li> <li>● Para obtener información de seguridad referente a los modos de activación Por contacto y Secuencial, lea el ‘Recordatorio de seguridad y de satisfacción del cliente’ (CSSR) en las cajas de la herramienta y de los sujetadores. Bajo determinadas condiciones, el modo de activación Secuencial puede reducir la probabilidad de que usted y otras personas que trabajen con usted sufran lesiones.</li> </ul>	<ul style="list-style-type: none"> <li>● Avec un mode de déclenchement séquentiel (restrictif), les clous ne peuvent être plantés que d’une seule façon. Appuyez d’abord la surface de contact (élément de sécurité) sur la pièce à travailler, puis actionnez la gâchette. Cette possibilité est commode quand un placement précis du clou est nécessaire.</li> <li>● Lisez le rappel sur la satisfaction du client et la sécurité (CSSR) sur l’outil et les boîtes de clous, à propos des consignes de sécurité sur les modes de déclenchement au toucher et séquentiel. Dans certaines conditions, le mode de déclenchement séquentiel peut diminuer la possibilité de blessures, pour vous ou ceux qui travaillent à proximité.</li> </ul>
 <ul style="list-style-type: none"> <li>● Always remove finger from trigger when not driving fasteners. Never carry the tool with finger on or under trigger. Tool will eject a fastener if the workpiece contact is bumped.</li> </ul>	<ul style="list-style-type: none"> <li>● Siempre quite el dedo del gatillo cuando no esté disparando clavos. Nunca cargue la herramienta con el dedo sobre o por debajo del gatillo. La herramienta disparará un clavo si se golpea el elemento de seguridad.</li> </ul>	<ul style="list-style-type: none"> <li>● Ôtez le doigt de la détente lorsque vous n’enfonchez pas d’agrafes. Ne transportez jamais l’outil avec le doigt sur la détente; l’outil tirera une agrafe si le palpeur de sécurité par pression est heurté.</li> </ul>
  <ul style="list-style-type: none"> <li>● TO AVOID SERIOUS INJURY FROM FASTENERS AND FLYING DEBRIS WHEN INSTALLING METAL CONNECTORS USING THE JOISTPRO NAILER:</li> <li>● Use only genuine Senco metal connector nails.</li> <li>● Metal connector nails are not designed to penetrate metal. When installing metal connectors, always place the exposed point of the metal connector nail into the metal connector’s pre-formed hole, and orient so the nail is perpendicular to the hole before attempting to drive a fastener.</li> <li>● Senco strongly recommends the use of hardened nails in the JoistPro tools.</li> </ul>	<ul style="list-style-type: none"> <li>● PARA EVITAR LESIONES SERIAS POR FIJACIONES Y RESIDUOS QUE VUELEN AL INSTALAR CONECTORES DE METAL USANDO CON EL ADITAMENTO CONECTOR DE METAL:</li> <li>● Use solamente los clavos conectores de metal genuinos de Senco.</li> <li>● Los clavos conectores de metal no están diseñados para penetrar el metal. Al instalar conectores de metal, siempre ponga la punta expuesta del clavo conector de metal en el agujero preformado del conector de metal, y oriente el clavo de tal modo que quede perpendicular al agujero antes de intentar instalar uno.</li> <li>● Senco recomienda clavos endurecido en las JoistPro herramientas.</li> </ul>	<ul style="list-style-type: none"> <li>● POUR ÉVITER LES BLESSURES CAUSÉES PAR DES ATTACHES ET DES DÉBRIS PROJÉTÉS AUMOMENT DE POSER DES CONNECTEURS MÉTALLIQUES À L’AIDE AVEC EMBOUT POUR MCNCONNECTEUR MÉTALLIQUE :</li> <li>● N’utiliser que des clous pour connecteur métallique d’origine Senco.</li> <li>● Les clous pour connecteur métallique ne sont pas conçus pour pénétrer le métal. Au moment d’installer des connecteurs métalliques, toujours placer la pointe visible du clou dans le trou préformé du connecteur, et orienter l’outil de façon que le clou soit perpendiculaire au trou avant d’enfoncer l’attache.</li> <li>● Senco recommande fortement clous durcis dans les JoistPro outils.</li> </ul>
<ul style="list-style-type: none"> <li>● <b>JoistPro150XP:</b> WORK CONTACT ELEMENT The moveable nose, which acts as the contact trip, is in the “depressed” position at rest to allow visibility of the nail points. When the tip of the nail is placed in the pre-punched metal connector hole and the trigger is pulled, the moveable nose moves out from the tool to detect the work surface. If the moveable nose does not detect the work surface close to the nose of the tool, the tool will not actuate.</li> </ul>	<ul style="list-style-type: none"> <li>● <b>JoistPro150XP:</b> ELEMENTO DE CONTACTO CON LA PIEZA DE TRABAJO La punta móvil, la cual actúa comodisparo de contacto, está en la posición “oprimida” en descanso para permitir la visibilidad de las puntas de clavos. Cuando se pone la punta del clavo en el agujero conector de metal preperforado y se acciona el gatillo, la punta móvil sale de la herramienta para detectar la superficie de trabajo cerca de la punta de la herramienta, no se activará la herramienta.</li> </ul>	<ul style="list-style-type: none"> <li>● <b>JoistPro150XP :</b> ELEMENT DE CONTACT AVEC PIECE Le nez de pose mobile, qui sert de déclencheur, reste en position « enfoncée » au repos afin de garder les pointes de clous visibles. Lorsque la pointe du clou est dans le trou pré-perfore connecteur métallique et que la gâchette est enfoncée, le nez sort de l’outil pour détecter la surface de travail. S’il ne détecte pas la surface près du nez de l’outil, l’outil ne s’actionnera pas.</li> </ul>

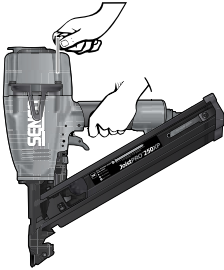
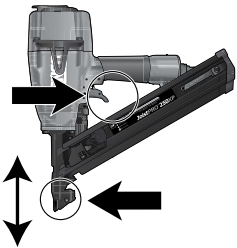
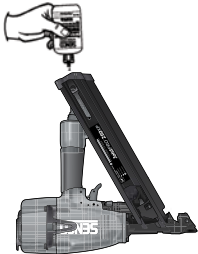

TOOL USE	USO DE LA HERRAMIENTA	UTILISATION DE L'OUTIL
ENGLISH	ESPAÑOL	FRANÇAIS
<ul style="list-style-type: none"> <li>● <b>JoistPro250XP:</b> To adjust the depth the fastener is driven, first disconnect the air supply. Using your thumb or index finger, rotate wheel to adjust the Depth Control safety element to achieve desired depth.</li> </ul>	<ul style="list-style-type: none"> <li>● <b>JoistPro250XP:</b> Para ajustar la profundidad de sujetador, dede primero desconectar el aire. Usando el dedo pulgar o el dedo indice, rote la manivela para ajustar el seguro a la profundidad deseada.</li> </ul>	<ul style="list-style-type: none"> <li>● <b>JoistPro250XP:</b> A l'aide du pouce ou de l'index, faire tourner la molette pour ajuster la position du palpeur de sécurité.</li> </ul>
<ul style="list-style-type: none"> <li>● Should a nail jam occur, disconnect air supply.</li> </ul>	<ul style="list-style-type: none"> <li>● Si se produce un altas-camiento de un clavo, desconecte el suministro de aire.</li> </ul>	<ul style="list-style-type: none"> <li>● Au cas ou il se produirait un coincage de clous, coupez l'alimentation en air.</li> </ul>
<ul style="list-style-type: none"> <li>● Release the feeder shoe and slide it forward. Remove fasteners from the tool.</li> </ul>	<ul style="list-style-type: none"> <li>● Suelte el alimentador y deslicelo hacia adelante. Retire los sujetadores de la herramienta.</li> </ul>	<ul style="list-style-type: none"> <li>● Relâcher le poussoir et le faire glisser vers l'avant. Enlever les projectiles.</li> </ul>
<ul style="list-style-type: none"> <li>● Remove the screw at the back of the tool and remove the magazine.</li> </ul>	<ul style="list-style-type: none"> <li>● Quite el tornillo de la parte trasera de la herramienta, y retire el cargador.</li> </ul>	<ul style="list-style-type: none"> <li>● Ôtez la vis à l'arrière de l'outil et sortez son magasin.</li> </ul>
<ul style="list-style-type: none"> <li>● Clear jammed fastener from guide body.</li> <li>● Reattach the magazine and fasten magazine mounting screw.</li> </ul>	<ul style="list-style-type: none"> <li>● Libre el sujetador de la placa de nariz.</li> <li>● Vuelva a fijar la revista y fijarlo el tornillo de montaje revista.fijarlo el tornillo de montaje revista.</li> </ul>	<ul style="list-style-type: none"> <li>● Extraire le clou coincé du front de l'appareil.</li> <li>● Rattachez le magazine et fixer la vis de montage du magazine.</li> </ul>
<ul style="list-style-type: none"> <li>● Connect air supply and replace fasteners. Pull feeder shoe back.</li> </ul>	<ul style="list-style-type: none"> <li>● Conecte la línea de aire y reemplace los clavos. Tire la zapata del alimentador.</li> </ul>	<ul style="list-style-type: none"> <li>● Reconnectez la conduite d'air comprimé et rechargez le magasin. Tirez le poussoir en arrière.</li> </ul>
<ul style="list-style-type: none"> <li>● To prevent eye injuries, always wear OSHA required "Z87" safety glasses with permanently attached rigid, hard plastic side shields. These safety glasses must have "Z87" printed or stamped on them. Be sure everyone in your work area is wearing the same type of safety glasses.</li> </ul>	<ul style="list-style-type: none"> <li>● Para prevenir lesiones en los ojos, use siempre los anteojos de seguridad "Z87" requeridos por OSHA con escudos lateralés rígidos de plástico duro y adheridos permanentemente. Estos anteojos de seguridad deben tener "Z87" marcado o impreso en ellos. Asegúrese que toda persona dentro de su area de trabajo use el mismo tipo de anteojos.</li> </ul>	<ul style="list-style-type: none"> <li>● Afin de protéger vos yeux contre les blessures, portez toujours des lunettes de sécurité OSHA "Z87" avec caches latéraux en plastique rigide. La mention "Z87" doit être imprimée ou poinçonnée sur ces lunettes de sécurité. Assurez-vous que toute personne se trouvant près du secteur de travail porte des lunettes de sûreté.</li> </ul>
<ul style="list-style-type: none"> <li>● Never use oxygen, carbon dioxide or any other bottled gas as a power source for this tool; the tool will explode and cause serious injury.</li> </ul>	<ul style="list-style-type: none"> <li>● Nunca use oxígeno, anhídrido carbónico o cualquier otro gas embotellado como fuente de fuerza para esta herramienta; la herramienta explotará y producirá lesiones graves.</li> </ul>	<ul style="list-style-type: none"> <li>● N'utilisez jamais de l'oxygène, du gaz carbonique ou tout autre gaz en bouteille comme source d'énergie pour cet outil ; cela causerait l'explosion de l'outil et entraînerait de graves blessures.</li> </ul>

MAINTENANCE		MANTENIMIENTO		ENTRETIEN			
ENGLISH		ESPAÑOL		FRANÇAIS			
		<ul style="list-style-type: none"> <li>• Disconnect the tool from the air supply and empty magazine. Read section titled "Safety Warnings" before maintaining tool.</li> </ul>		<ul style="list-style-type: none"> <li>• Antes de usar la herramienta lea y comprenda el manual "INSTRUCCIONES DE SEGURIDAD" despachado con ella.</li> </ul>		<ul style="list-style-type: none"> <li>• Lisez et assimilez le manuel "Instructions de sécurité" livré avec cet outil avant de l'utiliser.</li> </ul>	
		<ul style="list-style-type: none"> <li>• All screws should be kept tight. Loose screws result in unsafe operation and parts breakage.</li> </ul>		<ul style="list-style-type: none"> <li>• Todos los tornillos tienen que mantenerse apretados. Los tornillos sueltos pueden producir una operación no segura y quebraduras de partes.</li> </ul>		<ul style="list-style-type: none"> <li>• Toutes les vis doivent être maintenues serrées à fond. Les vis desserrées entraînent un manque de sûreté du fonctionnement et la rupture de pièces.</li> </ul>	
		<ul style="list-style-type: none"> <li>• With tool disconnected, make daily inspection to assure free movement of the workpiece contact (safety element) and trigger. Do not use tool if safety element or trigger sticks or binds.</li> </ul>		<ul style="list-style-type: none"> <li>• Con la herramienta desconectada, haga inspecciones diarias para asegurar el movimiento libre del seguro y del gatillo. No use la herramienta si el seguro o el gatillo se atorán.</li> </ul>		<ul style="list-style-type: none"> <li>• L'outil étant séparé de l'alimentation en air, effectuez une inspection journalière pour assurer le libre mouvement du palpeur de sécurité et de la détente. N'utilisez pas l'outil si le palpeur de sécurité ou la détente colle ou se coince.</li> </ul>	
		<ul style="list-style-type: none"> <li>• Squirt Senco pneumatic oil (5 to 10 drops) into the air inlet twice daily (depending on frequency of tool use). Other oils may damage O-rings and other tool parts.</li> </ul>		<ul style="list-style-type: none"> <li>• Aplique aceite neumático SENCO en la entrada de aire dos veces al día (dependiendo en la frecuencia de uso 5 A 10 Gotas). Otros aceites pueden dañar los anillos en "O" y otras piezas de la herramienta.</li> </ul>		<ul style="list-style-type: none"> <li>• Avec une burette, placer 5 à 10 gouttes d'huile pneumatique dans l'arrivée d'air deux fois par jour (dépend de l'intensité de l'utilisation de l'appareil). D'autres huiles pourraient endommager les joints toriques et d'autres pièces de l'outil.</li> </ul>	
		<ul style="list-style-type: none"> <li>• Wipe tool clean daily and inspect for wear. Use non-flammable cleaning solutions only if necessary—DO NOT SOAK. Caution: Such solutions may damage O-rings and other tool parts.</li> </ul>		<ul style="list-style-type: none"> <li>• Solamente si es necesario use soluciones para limpieza no flamables -NO LA REMOJE. Precaución: Tales soluciones pueden dañar los empaques y otras partes de la herramienta.</li> </ul>		<ul style="list-style-type: none"> <li>• Nettoyez l'outil chaque jour à l'aide d'un chiffon et inspectez-le pour déceler une éventuelle usure. Utilisez uniquement des solvants non inflammables en cas de nécessité-NE LE FAITES PAS TREMPER ! Attention : De tels produits peuvent endommager les joints et autres pièces de l'appareil.</li> </ul>	

TROUBLESHOOTING	IDENTIFICACIÓN DE FALLAS	DÉPANNAGE
ENGLISH	ESPAÑOL	FRANÇAIS
<p><b>WARNING</b></p> <p>Repairs other than those described here should be performed only by trained, qualified personnel. Contact SENCO for information at 1-800-543-4596.</p> <ul style="list-style-type: none"> <li>● I Read section titled "Safety Warnings" before maintaining tool.</li> </ul>	<p><b>ALERTA</b></p> <p>Las reparaciones, fuera de aquellas descritas aquí, deben de ser llevadas a cabo solamente por personal entrenado y calificado. Póngase en contacto con SENCO para información 1-800-543-4596.</p> <ul style="list-style-type: none"> <li>● I Lea la sección titulada "Avisos de Seguridad" antes de darle mantenimiento a la herramienta.</li> </ul>	<p><b>AVERTISSEMENT</b></p> <p>Les réparations autres que celles décrites ici doivent être réalisées uniquement par du personnel qualifié ayant reçu la formation appropriée. Pour toute information, prenez contact avec SENCO par téléphone en appelant Le Distributeur agréé.</p> <ul style="list-style-type: none"> <li>● I Lisez la section intitulée "Consignes de Sécurité" avant d'effectuer l'entretien de l'outil.</li> </ul>
<p><b>SYMPTOM</b></p> <ul style="list-style-type: none"> <li>● Air leak near top of tool / Sluggish operation.</li> </ul>	<p><b>SÍNTOMA</b></p> <ul style="list-style-type: none"> <li>● El aire se escapa cerca de la parte superior de la herramienta / Operación lenta.</li> </ul>	<p><b>SYMPTÔME</b></p> <p>Fuite d'air près du sommet de l'outil / fonctionnement lent.</p>
<p><b>SOLUTION</b></p> <ul style="list-style-type: none"> <li>● Verify air supply / tighten screws or install Parts Kit A.</li> </ul>	<p><b>SOLUCIÓN</b></p> <ul style="list-style-type: none"> <li>● Apriete los tornillos / Verifique el suministro de aire o instale el Juego de Partes A (Parts Kit A).</li> </ul>	<p><b>SOLUTION</b></p> <ul style="list-style-type: none"> <li>● Serrez les vis à fond / vérifiez l'alimentation en air ou remplacez les pièces portant la lettre "A".</li> </ul>
<p><b>SYMPTOM</b></p> <ul style="list-style-type: none"> <li>● Air leak near bottom of tool/ Poor return.</li> </ul>	<p><b>SÍNTOMA</b></p> <ul style="list-style-type: none"> <li>● El aire se fuga cerca de la parte inferior de la herramienta / Mal retorno.</li> </ul>	<p><b>SYMPTÔME</b></p> <ul style="list-style-type: none"> <li>● Fuite d'air près de la base de l'outil / retour inadéquat.</li> </ul>
<p><b>SOLUTION</b></p> <ul style="list-style-type: none"> <li>● Clean tool / tighten screws or install Parts Kit B.</li> </ul>	<p><b>SOLUCIÓN</b></p> <ul style="list-style-type: none"> <li>● Apriete los tornillos / Limpie la herramienta o instale el Juego de Partes B (Parts Kit B).</li> </ul>	<p><b>SOLUTION</b></p> <ul style="list-style-type: none"> <li>● Serrez les vis à fond / nettoyez l'outil ou remplacez les pièces portant la lettre "B".</li> </ul>
<p><b>SYMPTOM</b></p> <ul style="list-style-type: none"> <li>● Other problems.</li> </ul>	<p><b>SÍNTOMA</b></p> <ul style="list-style-type: none"> <li>● Otros problemas.</li> </ul>	<p><b>SYMPTÔME</b></p> <ul style="list-style-type: none"> <li>● Autres problèmes.</li> </ul>
<p><b>SOLUTION</b></p> <ul style="list-style-type: none"> <li>● Contact SENCO.</li> </ul>	<p><b>SOLUCIÓN</b></p> <ul style="list-style-type: none"> <li>● Póngase en contacto con SENCO.</li> </ul>	<p><b>SOLUTION</b></p> <ul style="list-style-type: none"> <li>● Prenez contact avec SENCO.</li> </ul>

English TECHNICAL SPECIFICATIONS	<b>JoistPro250X</b>		<b>JoistPro150XP</b>	
Min. to max. operating pressure	70–120 psi	4.8–8.3 bar	70–120 psi	4.8–8.3 bar
Air Consumption (60 cycles per min)	4.1 scfm	117.5 liter/min.	2.3 scfm	65.9 liter/min.
Air Inlet	¼ in. NPT	¼ in. NPT	¼ in. NPT	¼ in. NPT
Weight	5.9 lbs.	2.68 kg	4.6 lbs.	2.08 kg
Fastener Capacity	20	20	30	30
Tool size: Height	14.13 in.	359 mm	11.97 in.	304 mm
Tool size: Length	13.78 in.	350 mm	10.35 in.	263 mm
Tool size: Width: Main Body	4.33 in.	110 mm	3.94 in.	100 mm
Operating Temperature Range	0° to 120°F	-18° to 49°C	0° to 120°F	-18° to 49°C
Fastener Size	1 1/2 -2 1/2" (40-65 mm) Length .131-.162" (3.3-4.1 mm) Diameter		1 1/2 " (40 mm) Length .131-.148" (3.3-3.8 mm) Diameter	

Note: When you use 60mm nails it could be possible that you need to increase your air pressure

Español ESPECIFICACIONES TECNICAS	<b>JoistPro250X</b>		<b>JoistPro150XP</b>	
Presión de operación mínima y máxima	70–120 psi	4.8–8.3 bar	70–120 psi	4.8–8.3 bar
Consumo de aire (60 ciclos por minuto)	4.1 scfm	117.5 liter/min.	2.3 scfm	65.9 liter/min.
Entrada de aire	¼ in. NPT	¼ in. NPT	¼ in. NPT	¼ in. NPT
Peso	5.9 lbs.	2.68 kg	4.6 lbs.	2.08 kg
Capacidad de grapas por cargador	20	20	30	30
Tamaño de la herramienta: Altura	14.13 in.	359 mm	11.97 in.	304 mm
Tamaño de la herramienta: Longitud	13.78 in.	350 mm	10.35 in.	263 mm
Tamaño de la herramienta: Ancho (Cuerpo)	4.33 in.	110 mm	3.94 in.	100 mm
Rango de temperatura de	0° to 120°F	-18° to 49°C	0° to 120°F	-18° to 49°C
Tamaño del clavo	1 1/2 -2 1/2" (40-65 mm) Largo .131-.162" (3.3-4.1 mm) Diametro		1 1/2 " (40 mm) Largo .131-.148" (3.3-3.8 mm) Diametro	

Nota: Cuando usted utiliza clavos de 60 mm podría ser posible que usted necesite incrementar la presión.

Français SPECIFICATIONS TECHNIQUES	<b>JoistPro250X</b>		<b>JoistPro150XP</b>	
Pression de travail min. et max.	70–120 psi	4.8–8.3 bar	70–120 psi	4.8–8.3 bar
Consommation d'air (60 cycles par minute)	4.1 scfm	117.5 liter/min.	2.3 scfm	65.9 liter/min.
Admission d'air	¼ in. NPT	¼ in. NPT	¼ in. NPT	¼ in. NPT
Poids	5.9 lbs.	2.68 kg	4.6 lbs.	2.08 kg
Capacité de projectiles par magasin	20	20	30	30
Dimensions de l'outil: hauteur	14.13 in.	359 mm	11.97 in.	304 mm
Dimensions de l'outil: longueur	13.78 in.	350 mm	10.35 in.	263 mm
Dimensions de l'outil: largeur: corps de l'appareil	4.33 in.	110 mm	3.94 in.	100 mm
Température de fonctionnement	0° to 120°F	-18° to 49°C	0° to 120°F	-18° to 49°C
Dimension d'pointe	1 1/2 -2 1/2" (40-65 mm) Longueur .131-.162" (3.3-4.1 mm) Diametre		1 1/2 " (40 mm) Longueur .131-.148" (3.3-3.8 mm) Diametre	

Lorsque vous utilisez des clous de 60 mm, il se peut que vous deviez augmenter la pression d'air

ACCESSORIES	ACCESORIOS	ACCESSOIRES
ENGLISH	ESPAÑOL	FRANÇAIS
<p>SENCO offers a full line of accessories for your SENCO tools, including:</p> <ul style="list-style-type: none"> <li>● Air Compressors</li> <li>● Hose</li> <li>● Couplers</li> <li>● Fittings</li> <li>● Safety Glasses</li> <li>● Pressure Gauges</li> <li>● Lubricants</li> <li>● Regulators</li> <li>● Filters</li> </ul> <p>For more information or a complete illustrated catalogue of SENCO accessories, ask your representative for #MK336.</p>	<p>SENCO ofrece una línea completa de Accesorios para sus herramientas SENCO, incluyendo:</p> <ul style="list-style-type: none"> <li>● Compresores de Aire</li> <li>● Manguera</li> <li>● Conectores Rápidos</li> <li>● Conectores</li> <li>● Antojos De Seguridad</li> <li>● Manómetros</li> <li>● Lubricantes</li> <li>● Reguladores</li> <li>● Filtros</li> </ul> <p>Para mas información ó un para recibir un catalogo completo ilustrado de los Accesorios SENCO, pregunte a su representante para el numero MK336.</p>	<p>SENCO offre une gamme étendue d'accessoires pour vos outils SENCO y compris:</p> <ul style="list-style-type: none"> <li>● Compresseurs</li> <li>● Tuyauterie flexible</li> <li>● Raccords</li> <li>● Lunettes de sécurité</li> <li>● Manomètres</li> <li>● Lubrifiants</li> <li>● Régulateurs</li> <li>● Filtres</li> </ul> <p>Pour plus d'informations ou pour recevoir un catalogue détaillé des accessoires proposés par SENCO, prenez contact avec votre représentant SENCO (référence catalogue : #MK336).</p>



**Limited Warranty**  
**SENCO® Pneumatic, DuraSpin®, Cordless Tools**  
**& Compressors**

Senco Products, Inc. ("SENCO") designs and constructs its products using the highest standards of material and workmanship. SENCO warrants to the original retail purchaser that the following products will be free from defects in material or workmanship for the warranty period specified below:

<b>Pneumatic tools (both XP and Pro)</b> Five Years	<b>Fusion Tools</b> Two Years	<b>Combo Kit Tools</b> One Year	<b>GasTools</b> Two Years
<b>Duraspin Tools</b> One Year	<b>Air Compressors</b> One Year	<b>Multi-Blow Hand Nailers &amp; Stapling Hammers</b> One Year	

During the warranty period (which begins on the purchase date), SENCO will repair or replace, at SENCO's option and expense, any product or part that is defective in materials or workmanship after examination by a SENCO Authorized Warranty Service Center, subject to the exceptions, exclusions and limitations described below. Any replacement product or part will carry a warranty for the balance of the warranty period applicable to the replaced product or part. A DATED SALES RECEIPT OR PROOF OF PURCHASE FROM THE ORIGINAL RETAIL PURCHASER IS REQUIRED TO MAKE A WARRANTY CLAIM. Warranty registration also is required and can be accomplished through on-line Product Registration at [www.senco.com](http://www.senco.com) or by completing and returning the postage paid warranty registration form included with your Operator's manual/parts chart information, found inside the product carton. To make a warranty claim, you must return the product, with proper receipt/proof of purchase and return transportation charges prepaid, to a SENCO Authorized Warranty Service Center. A list of SENCO Authorized Warranty Service Centers can be found at [www.senco.com](http://www.senco.com) or by calling 1-800-543-4596 toll free. SENCO will perform its obligations under this warranty, within a reasonable time after approval of the warranty claim.

**Wheelbarrow Compressors:**

- Subject to the exceptions, exclusions and limitations described below, SENCO warrants that the compressor pump will be free from defects in materials and workmanship for two years after the purchase date.
- Defective parts of the compressor pump not subject to normal wear and tear will be repaired or replaced, at SENCO's option, during the two year warranty period. If SENCO determines that repair or replacement is not feasible, SENCO will refund the purchase price less reasonable depreciation based on actual use.

**SENCO Cordless:**

- Subject to the exceptions, exclusions and limitations described below, SENCO warrants that the SENCO Cordless tool will be free from defects in materials and workmanship for two years after the purchase date.
- SENCO warrants that the batteries and chargers used with SENCO Cordless tools will be free from defects in material and workmanship for one year after the purchase date.

**WARRANTY EXCLUSIONS**

The following warranty exclusions apply:

- Normal wear parts are not covered under this warranty. Normal wear parts include, for example, isolators, drive belts, air filters, rubber o-rings, seals, driver blades, piston stops, and piston/driver assembly.
- This warranty does not cover parts damaged due to normal wear, misapplication, misuse, accidents, operation at other than recommended speeds or voltage (electric units only), improper storage, or damage resulting during shipping.
- Products used in production/industrial applications as defined by SENCO are excluded from this warranty.
- Labor charges or loss or damage resulting from improper operation, maintenance or repairs are not covered by this warranty.
- SENCO does not warrant the Wheelbarrow Compressor Engine/Motor, but the Compressor Engine/Motor may be covered under a warranty offered by its manufacturer.

**GENERAL WARRANTY CONDITIONS**

This warranty will be honored, only if:

- Clean, dry, regulated compressed air has been used, at air pressure not exceeding the maximum indicated on the tool casting;
- No evidence of abuse, abnormal conditions, accident, neglect, misuse or improper modifications or storage of the product; and
- No Deviation from operating instructions, specifications, and maintenance schedules exists (read Operator Manual for use, specifications, and maintenance instructions).

THIS WARRANTY IS THE ONLY WARRANTY ON THE PRODUCT, AND SENCO DISCLAIMS ALL OTHER WARRANTIES. ANY IMPLIED WARRANTIES WILL BE LIMITED IN DURATION TO THE APPLICABLE WARRANTY PERIOD SPECIFIED ABOVE. SOME STATES DO NOT ALLOW LIMITATIONS ON HOW LONG AN IMPLIED WARRANTY LASTS, SO THE ABOVE LIMITATION MAY NOT APPLY TO YOU. YOUR REMEDIES ARE SOLELY AND EXCLUSIVELY AS STATED ABOVE. SENCO SHALL IN NO EVENT BE LIABLE FOR INCIDENTAL, CONSEQUENTIAL, INDIRECT, OR SPECIAL DAMAGES. SOME STATES DO NOT ALLOW THE EXCLUSION OR LIMITATION OF INCIDENTAL OR CONSEQUENTIAL DAMAGES, SO THE ABOVE LIMITATION OR EXCLUSION MAY NOT APPLY TO YOU. IN NO EVENT, WHETHER AS A RESULT OF A BREACH OF CONTRACT, WARRANTY, TORT (INCLUDING NEGLIGENCE) OR OTHERWISE, SHALL SENCO'S LIABILITY EXCEED THE PRICE OF THE PRODUCT WHICH HAS GIVEN RISE TO THE CLAIM OR LIABILITY. ANY LIABILITY CONNECTED WITH THE USE OF THIS PRODUCT SHALL TERMINATE UPON THE EXPIRATION OF THE WARRANTY PERIOD SPECIFIED ABOVE. NO EMPLOYEE OR REPRESENTATIVE OF SENCO OR ANY DISTRIBUTOR OR DEALER IS AUTHORIZED TO MAKE ANY CHANGE OR MODIFICATION TO THIS WARRANTY.

This warranty gives you specific legal rights, and you may also have other rights which vary from state to state.

**REPLACEMENT OF TOOL DUE TO NATURAL DISASTER**

SENCO will replace any tool destroyed by an Act of God such as flood, earthquake, hurricane or other disaster resulting only from the forces of nature. Such a claim will be honored provided that such original retail purchaser had previously submitted a completed warranty registration card for the tool, and then submits proof of ownership and an acceptable statement describing such Act of God documented by an insurance carrier, police department, or other official governmental source. To obtain instructions for filing a claim call 1-800-543-4596.

**CUSTOMER SATISFACTION**

One hundred percent customer satisfaction is our #1 goal. If for any reason the product does not perform to the original purchaser's satisfaction, it can be returned to the place of purchase **within thirty days** with dated sales receipt for a full refund of the purchase price.